

## MODULAR FLAT GATE VALVE TYPE SMFS-HD

### SHUT-OFF - COMPONENT FOR SILO AND CONTAINER SYSTEMS WITH OPTIMAL SEALING – HAND DRIVEN



The **modular gate valve TYPE SMFS-HD** is attached to silo and vessel discharges and assures the optimal sealing of stored dusty and granular bulk goods up to 8 mm in size. This modular gate allows the installation of various drive configurations - manual, pneumatic, or electric motor driven - on the same base frame.

#### Areas of Application

- Grain size up to 8 mm
- High quality gate plate sealing; packing box easily adjustable and exchangeable
- Slide plate made of stainless steel 1.4301, ground
- Steel guide on the slide gates upper side
- Ball track rollers sealed on both sides
- Large, easily removable protective covers
- Low overall height
- Ex-protected
- Special paintwork on request
- Special sizes on request
- High-temperature version
- position indicator
- Other materials: e.g. stainless steel 1.4301 / 1.4571

#### Details / Explanation

- Rust removal: SA 2,5
- Primer: 2K; 40µm
- Top coat: 2K; RAL 9006; 40µm

#### Finish

**Spare parts drawing**

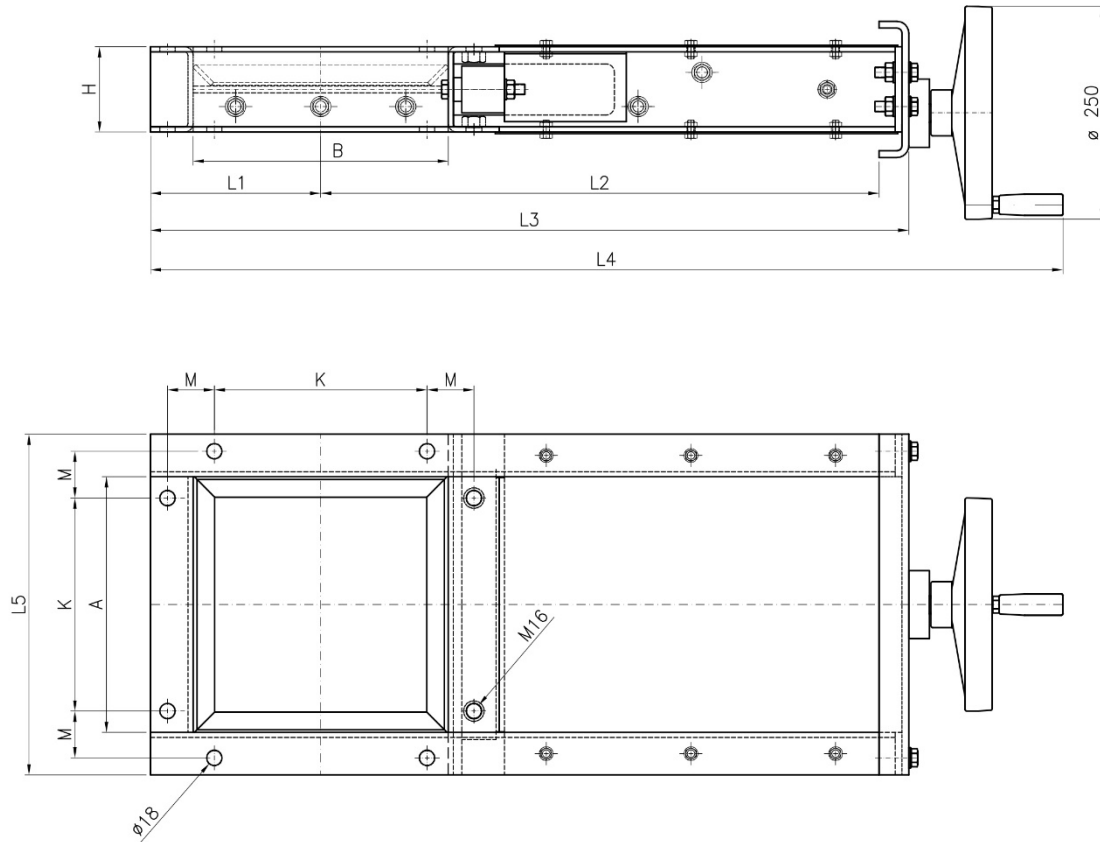

**Dimensions Flat Gate Type SMFS - HD**

AxB [mm]	Article No.	Weight [kg]	K [mm]	M [mm]	L1 [mm]	L2 [mm]	L3 [mm]	L4 [mm]	L5 [mm]	H [mm]
200x200	712 10 278	40	150	55	150	507	690	870	300	100
250x250	712 10 294	43	200	55	175	575	790	970	350	100
300x300	712 10 269	46	250	55	200	650	890	1070	400	100
350x350	712 10 301	55	280	65	225	726	990	1170	450	100
400x400	712 10 272	59	300	80	250	800	1090	1270	500	100
450x450	712 10 296	62	330	90	275	881	1190	1370	550	100
500x500	712 10 275	65	350	105	300	950	1290	1470	600	100
600x600	712 10 305	87	380	120	325	1025	1390	1570	700	120

Subject to technical changes

**Special solutions gate valve type SMFS - HD**  
**Special sizes on request**

**Notice**





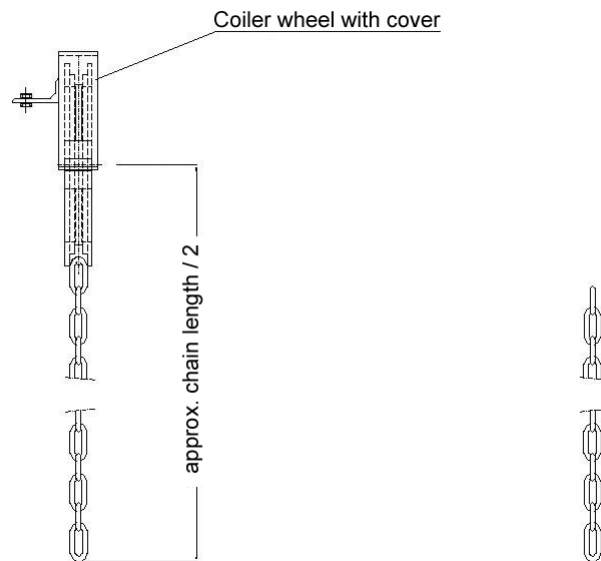

**OPTION: Actuation / reel wheel**





**Specify chain length when ordering**

D1 [mm]	Reel wheel Art No.	Weight [kg]	Chain according to DIN 766 Art No.	Weight / m [kg]
260	712 10 135	5	712 10 136	0,75

**Accessories / Spare parts**

	Article No.	
Handwheel	712 10 132	
Ball bearing - standard	712 10 143	
Bearing bush for manual slide valve	712 10 268 109	
Spacer sleeve	60-108	
Trapezoidal screw nut	712 10 269 108	

	Type	Article No.	
Trapezoidal threaded spindle	SMFS 200 x 200	712 10 278 107	
	SMFS 250 x 250	712 10 294 107	
	SMFS 300 x 300	712 10 269 107	
	SMFS 350 x 350	712 10 301 107	
	SMFS 400 x 400	712 10 272 107	
	SMFS 450 x 450	712 10 296 107	
	SMFS 500 x 500	712 10 275 107	

	Type	Article No.	
Stuffing box packing / Gasket Set for 1 slider (3 pieces)	SMFS 200 x 200	712 10 285	
	SMFS 250 x 250	712 10 286	
	SMFS 300 x 300	712 10 287	
	SMFS 350 x 350	712 10 288	
	SMFS 400 x 400	712 10 289	
	SMFS 450 x 450	712 10 290	
	SMFS 500 x 500	712 10 291	

	Type	Article No.	
Gasket block	SMFS 200 x 200	712 10 278 102	
	SMFS 250 x 250	712 10 294 102	
	SMFS 300 x 300	712 10 268 102	
	SMFS 350 x 350	712 10 282 102	
	SMFS 400 x 400	712 10 274 102	
	SMFS 450 x 450	712 10 296 102	
	SMFS 500 x 500	712 10 275 102	

	Type	Article No.	
Slide plate	SMFS 200 x 200	712 10 278 101	
	SMFS 250 x 250	712 10 294 101	
	SMFS 300 x 300	712 10 268 101	
	SMFS 350 x 350	712 10 282 101	
	SMFS 400 x 400	712 10 274 101	
	SMFS 450 x 450	712 10 296 101	
	SMFS 500 x 500	712 10 275 101	